



Das Auto.

The Golf Estate





Model shown is Golf Estate Sportline with optional pearl effect paint.

Open yourself up to a new experience.

Life is all about enjoying the journey, and discovering what inspires you along the way. It's about turning your dreams into reality and discovering new experiences. So, finding a car that has the capacity to meet your changing needs isn't always easy. With the Golf Estate this will never be a problem again. It has an impressive stowage capacity and flexible interior layout, allowing you to transport any combination of large loads, passengers, luggage, pets and more. This, combined with a sleek design, quality finish, numerous safety features and a variety of trim levels mean the Golf Estate is perfectly equipped to meet your needs, however many twists and turns your life may take.

Expand your horizons.



Model shown is Golf Estate Sportline with optional panoramic electric sunroof and metallic paint.



The optional **panoramic sunroof** adds an extra dimension of light and space.

Breathe in the fresh air.

Starry night or sunlit day, you can enjoy either in abundance in the Golf Estate. The optional panoramic sunroof creates a sensation of light and space, adding an extra dimension of freedom and fresh air, whatever the season, giving you an uninterrupted view of the sky above. And if it gets too hot or too cold, simply close the sunroof at the touch of a button. The controls are easily located in the roof console above you, and they also control the electric sunblind, offering further protection from the heat and glare. Local trip or travelling the world, it makes no difference in the Golf Estate.



The **rear light clusters** are styled to follow the dynamic bodylines.



Elegant **chrome side window surrounds** and **heat insulated tinted glass from the B pillar back**, give greater definition to the Sportline.



Black roof rails are a handy and practical addition to the exterior of the S.



Front fog lights offer additional safety in dull weather and provide an extra touch of style to Sportline models.



The door mirrors are **electrically heated and adjustable with integrated indicators** for greater visibility and safety.



Model shown is Golf Estate Sportline with optional pearl effect paint.

Room for everything.

The Golf Estate has room for just about everything. With a stowage capacity of up to 1,550 litres, it's ready for anything your day may have in store for you, from walking the dog to going on holiday. It features numerous practical details, such as a retractable and removable luggage cover and handy storage compartments in the front and rear doors as well as in the roof console. The 60:40 split folding rear seat that folds flat into the boot floor enables you to stow large loads or carry a combination of passengers and luggage, while the height-adjustable driver's seat provides an ideal driving position. As you can tell, flexibility is top priority in the Golf Estate.



Keep your luggage safely in place with the retractable **net partition**. This option has a two position usage and can be used with the seats upright or when folded flat.



The rear seat and backrest splits 60:40, enabling you to transport both passengers and large or bulky items.



Drawers beneath the front seats, on SE and Sportline models, provides handy storage space for all those bits and pieces you need during your journey.



The useful **storage compartment** in the roof provides additional storage space for smaller items.



The **front centre armrest** with storage compartment also provides the rear seat passengers with two air vents and cup holders on SE and Sportline models.



The **multifunction computer (Highline)** on BlueMotion and Sportline models, provides essential information about your journey at a glance.



Fall in love.

Sleek, stylish and dependable, your Golf Estate will accompany you through all the twists and turns of life. Combining the quality and style of a Golf with the flexibility and space of an estate, what greater travelling companion could you ask for? Available in four trim levels, the S, BlueMotion, SE and Sportline models, there is sure to be a model to suit you, whatever your tastes or budget.

Model shown is Golf Estate Sportline with optional metallic paint.



The comfortable interior of the S featuring 'Glow' upholstery, is spacious and contemporary, with perfect ergonomics ensuring everything is ready to hand.

The Golf Estate S and BlueMotion Golf Estate.

The Golf Estate S and BlueMotion, ideally suited to meet the most varied of demands. The height-adjustable driver's seat, for example, adapts to your exact requirements, as does the 60:40 split folding rear seat, enabling you to carry both passengers and luggage. In the rear, there are four load lashing points as well as two bag hooks, a luggage compartment light helps you find things in the dark whilst the removable and retractable luggage cover keeps items away from prying eyes.

The central locking is conveniently operated remotely using the key, while a simple push of a button activates the front and rear electric windows. 'Climatic' air conditioning with semi-automatic control which also cools the glovebox, a radio/MP3 compatible CD player with four speakers and front reading lights add to the interior equipment. Designed to more than meet your every expectation, the Golf Estate S really is a perfect match.

The BlueMotion model, however, represents the most efficient and economical vehicle in the Golf Estate range. While still benefiting from all the features of the S model, the introduction of low rolling resistance tyres and sports suspension translate to improved fuel economy and reduced CO₂ emissions. To assist even further, the Highline multifunction computer also has an additional feature that provides a visual gear change recommendation for optimum fuel consumption. This fuel efficiency does not, however, reduce its agility. The acceleration and top speed of the BlueMotion Golf Estate remain unchanged from the Golf Estate S. That is key to the BlueMotion philosophy: fuel efficiency and agility in a combination that still makes driving fun.



'Climatic' air conditioning with semi-automatic control produces a pleasant, consistent temperature all year round.



Black roof rails provide even more practicality to the Golf Estate.



The height-adjustable driver's seat ensures maximum comfort and convenience, especially important on long journeys.



Front seat side impact airbags for the driver and front passenger, combined with curtain airbags provide a high level of safety.



The exterior door mirrors are electrically heated and adjustable as well as body-coloured to your chosen paint finish.



The beautifully crafted **high quality materials of the SE, upholstered in 'Maxima' cloth**, create the perfect ambience in the ergonomically designed interior.

The Golf Estate SE.

You only have to sit in the Golf Estate SE to appreciate its exceptional levels of comfort and functionality. The front comfort seats with height and lumbar adjustment provide excellent support ensuring good posture whilst driving, the drawers beneath offer useful storage for any items you may need. Also beneficial on long journeys is cruise control, enabling you to sit back and relax while maintaining a constant speed, and 'Climatic' air conditioning with semi-automatic control, keeps the temperature just right. The multifunction computer (Midline) provides important information about your journey, such as exterior temperature and fuel consumption. Interior features continue with a rain sensor and automatic dimming interior rear-view mirror, dusk sensor and the automatic coming/leaving home lighting function and front footwell illumination which lights your entry and exit from your vehicle. Outside, the 16 inch 'Toronto' alloy wheels, chrome side window surrounds and chrome-plated roof rails complete the look.



'Toronto' design 6½ x 16 light alloy wheels with 205/55 R16 tyres add to the exterior styling of the SE.



Chrome-plated roof rails further enhance the exterior look. The panoramic sunroof is optional at extra cost.



The front centre armrest has a handy storage compartment and also provides the rear seat passengers with two rear air vents and cup holders for comfort and convenience.



Bulky items can be transported easily and conveniently thanks to the load-through provision with rear centre armrest. Interior shown is Golf Estate SE with optional leather* upholstery. * Some parts of leather interior will contain artificial leather.



Cruise control can be set at speeds over 19 mph to maintain a constant speed. So even on long journeys you can have a high degree of relaxation.



The interior of the Golf Estate Sportline with optional sumptuous **leather upholstery***, **radio system RCD 500** and **2Zone electronic climate control**.

The Golf Estate Sportline.

Dynamic appearance and sports performance go hand in hand in the Golf Estate Sportline. Sporting aesthetics include 17 inch 'ClassiXs' light alloy wheels with 225/45 R17 tyres and sports suspension lowered by approximately 15 mm, ensuring safe and spectacular handling. The Sportline is also distinguished by the rear tinted windows from B pillar back, front fog lights, chrome-plated roof rails and chrome side window surrounds. Front sports seats with height and lumbar support not only provide optimum support when cornering, but also accentuate the sportiness, while the handbrake grip, gear lever knob and multifunction steering wheel in luxurious leather reinforce the feel of high quality and attention to detail. The multifunction steering wheel also provides controls for the radio/MP3 compatible CD player and multifunction computer, and if you choose an automatic DSG gearbox, your multifunction steering wheel will include paddle shift. The interior of the Sportline has comfort and convenience in mind, with remote central locking, alarm with interior protection, automatic coming/leaving home lighting function, dusk sensor, rain sensor and automatic dimming interior rear-view mirror and front footwell illumination. Take off and explore in the Golf Estate Sportline.



The **automatic coming/leaving home lighting function** will illuminate your entry and exit to your vehicle.



Front sports seats provide optimum support and comfort.



The **handbrake grip** in leather looks and feels luxurious.



Front fog lights offer additional safety in dull weather and give an extra touch of style to the front grille. Standard on Sportline and optional on S and SE models.



'ClassiXs' design 7J x 17 light alloy wheels with 225/45 R17 tyres. Standard on Sportline models.

All passengers welcome. Large and small.



Model shown is Golf Estate SE with optional leather upholstery and pearl effect paint.



Model shown is Golf Estate Sportline with optional metallic paint.

Keeping safe.

Sleek body lines and dynamic styling are the epitome of classic Golf design. But it's not just about looks. It's about intelligent technology and advanced body building techniques creating a car that ensures maximum safety on every trip. The Electronic Stabilisation Programme (ESP) for example, provides optimum traction and cornering stability. Supported by the Traction Control system (ASR) and Electronic Differential Lock (EDL), with an Anti-lock Braking System (ABS) to prevent the wheels from locking in the event of sudden braking, you feel really safe in the Golf Estate. Safety of other road users is taken into consideration by the automatic hazard light activation under emergency braking. An abundance of airbags only reinforces the story, with driver and front passenger airbags with passenger's airbag deactivation, front seat side impact airbags and curtain airbags for both front and rear seat passengers providing the highest levels of protection. Interior safety features continue with a warning light and buzzer for seat belts if unfastened and Isofix child seat preparation for the two outer rear seats which allows an Isofix child seat to be mounted directly onto the vehicle chassis.



Whiplash-optimised head restraints can easily be adjusted to suit both driver and front passenger. Interior shown is Golf Estate SE with optional leather* upholstery.



The curtain airbag system provides additional protection for front and rear seat passengers.



Three-point automatic seat belts are fitted to all five seats to supplement safety.



Reflectors are fitted on all doors, helping to increase safety when entering and leaving the vehicle.



Front seat side impact airbags for the driver and front passenger provide a high level of safety.



Front fog lights offer additional safety in dull weather and give an extra touch of style to the front grille. Standard on Sportline and optional on S and SE models.

* Some parts of leather interior will contain artificial leather.



Part of the family.

Model shown is Golf Estate Sportline with optional Winter pack and pearl effect paint.

Optional equipment.

Whichever model you choose from the Golf Estate range, you have a choice to enhance it even further with our wide range of optional equipment. By choosing from our Winter or Convenience packs, sumptuous leather upholstery, radio system upgrade or panoramic sunroof, just imagine how you could build a car to your personal specification.



The **coming/leaving home lighting function**, with **automatic headlights on**, will illuminate the path to your front door or to your car and is part of the **Convenience pack**. Also included is an **automatic dimming interior rear-view mirror**, **rain sensor** and **front footwell illumination**. Optional on S and BlueMotion and standard on SE and Sportline models.

Please note: Convenience pack and Luxury pack cannot be specified in conjunction with each other. Please consult your Volkswagen retailer for full details.



The **Luxury pack** includes a rain sensor and automatic dimming interior rear-view mirror, electrically foldable door mirrors with reverse activated kerb-view adjustment on the passenger's mirror, dusk sensor, coming/leaving home surrounding area lighting function and front footwell illumination. Optional on all models.

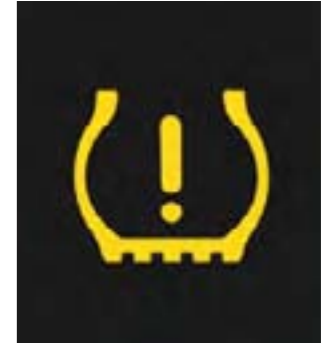

The **Sensor pack** includes ultrasonic **rear parking sensors** which emit an audible warning as objects become closer, **cruise control** which can maintain a constant speed from 19 mph upwards and automatically switches off when the brake or clutch is engaged and an **electronic tyre pressure monitoring system** which alerts you should a tyre lose pressure. In addition the Sensor pack also features **reverse activated kerb-view adjustment on the passenger's door mirror**. Optional on all models.



The **Winter pack** offers comfort and safety during the coldest months. The Winter pack includes heated front seats, heated windscreen washer jets, headlight washers and a low washer fluid level warning light. Optional on all models.



Leather* not only looks great, it's durable and easy to maintain. The leather upholstery option features heated leather front sports seats with individual preset temperature settings. Also included in this option is electrically-adjustable lumbar support for the driver's seat. This four-way lumbar support function is designed for comfort and support by providing greater and easier adjustment. On SE models, this option features a leather trimmed three-spoke steering wheel, gear knob and handbrake grip. Optional on SE and Sportline models.

* Some parts of leather interior will contain artificial leather.

Optional equipment (continued).



The **DVD touch-screen navigation/radio system** not only delivers perfect sound quality, but it can also guide you to your destination in any one of 24 European countries. A 6½" high resolution touch-screen colour display shows a perspective (birdseye) view of your mapped route, in addition, traffic information (TMC) enabled, landmarks, intersection zoom, points of interest and a route list can all be viewed. As well as featuring the latest in processor technology, resulting in quick route calculations this sophisticated system features a 30 GB hard drive to buffer the navigation data as well as store the driver's favourite audio and video files (i.e. MP3, WMA, DVD video data files), the integrated DVD drive and SD (Secure Digital) card reader also allows the playback of such audio and video files. Completing the multimedia experience is the ability to connect an external multimedia device (e.g. iPod) via the AUX-in socket. This option can also be specified with an armrest-mounted six CD autochanger. Optional on SE and Sportline models.



The **Radio system RCD 500 including dash-mounted MP3 compatible six CD autochanger** comes with ten speakers – six front and four rear – for near perfect acoustics. Optional on SE and Sportline models.

Please note: Radio system RCD 500 and DVD touch-screen navigation/radio system cannot be specified in conjunction with each other. Please consult your Volkswagen retailer for full details.



The **2Zone electronic climate control** is fully automatic to retain a precise internal temperature and includes automatic air recirculation function. It also benefits from a twin zone setting that allows the driver and front passenger up to 4°C difference in their chosen temperature settings. Even the glovebox is chilled should you be carrying snacks on your journey. Optional on all models.

Heated front seats form part of the **Winter pack** which offers comfort and safety during the coldest months. The Winter pack also includes heated windscreen washer jets, headlight washers and a low washer fluid level warning light. Optional on all models.



The **multifunction steering wheel** allows convenient operation of the radio and multifunction computer (Highline). Optional on SE and standard on Sportline models.



The **multifunction computer (Highline)** provides essential information about your journey at a glance. Standard on BlueMotion and Sportline. Optional on SE models.



Front fog lights offer additional safety in dull weather and give an extra touch of style to the front grille. Standard on Sportline. Optional on S, BlueMotion and SE models.

Optional equipment (continued).



When transporting loose items, the retractable **net partition** can be used when the seats are upright or folded flat to help protect passengers. Optional on all models.

The **alarm with interior protection** provides formidable protection through its acoustic and optical features. An electronic engine immobiliser, as well as back-up horn ensures further security. Standard on SE and Sportline and optional on S and BlueMotion models.



Bi-Xenon headlights including automatic range adjustment and headlight washers produce a brighter, clearer light for both dipped and main beam, giving you a clearer view of the road ahead and helping you to drive more safely. Optional on SE and Sportline models.



'**Toronto**' design 6½ x 16 light alloy wheels with 205/55 R16 tyres. Standard on SE models.



'**ClassiXs**' design 7 x 17 light alloy wheels with 225/45 R17 tyres. Standard on Sportline models.



'**Grand Prix**' design 7 x 17 light alloy wheels with 225/45 R17 tyres. Optional on SE and Sportline models.









The **panoramic sunroof**, measuring approximately 1.1 m², adds a new dimension of light and space to your Golf Estate. Easy to operate, at just the touch of a button, it opens automatically, allowing fresh air to enter, and enabling your passengers to enjoy a light, airy atmosphere. Blinds are also included, offering protection from strong sunlight. Optional on all models.



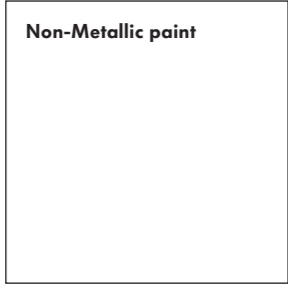

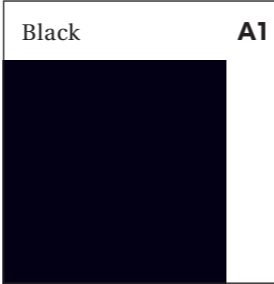
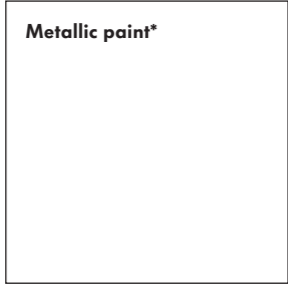

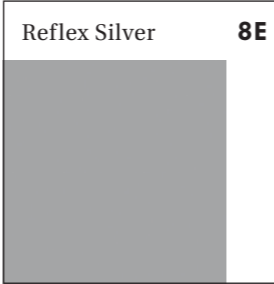
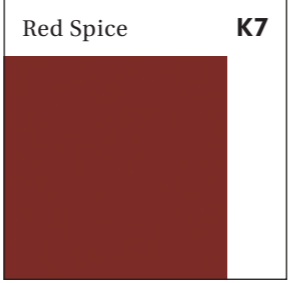
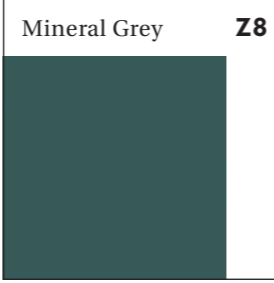

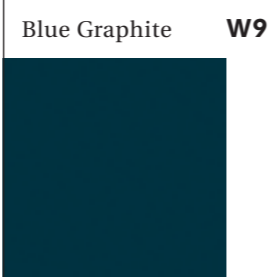
Enjoy the best seats.

Model shown is Golf Estate Sportline with optional pearl effect paint.

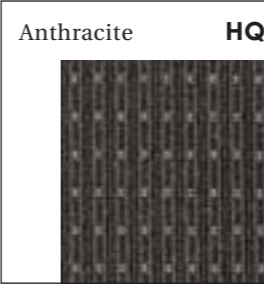
Paint.

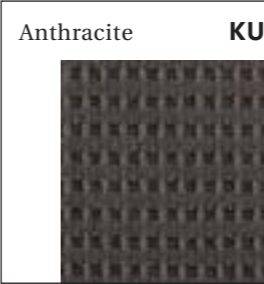
<p>Non-Metallic paint</p> 	<p>Salsa Red 4Y</p> 	<p>Black A1</p> 
<p>Metallic paint*</p> 	<p>Platinum Grey 2R</p> 	<p>Reflex Silver 8E</p> 
	<p>Red Spice K7</p> 	<p>Mineral Grey Z8</p> 
<p>Pearl effect paint*</p> 	<p>Deep Black 2T</p> 	<p>Blue Graphite W9</p> 

Upholstery.

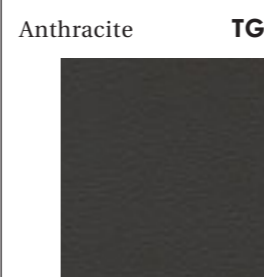
<p>'Glow' cloth upholstery</p>  <p>Standard on S, BlueMotion</p>	<p>Anthracite HQ</p> 
<p>'Maxima' cloth upholstery</p>  <p>Standard on SE</p>	<p>Anthracite KU</p> 
<p>'Brick' cloth upholstery</p>  <p>Standard on Sportline</p>	<p>Anthracite UL</p> 
<p>'Vienna' leather* †</p>  <p>Optional on SE and Sportline</p>	<p>Anthracite TG</p> 

* Metallic, pearl effect paints and leather upholstery are optional at extra cost.

† Some parts of leather interior will contain artificial leather.

Please note: Screen technology does not allow exact reproduction of the paint and upholstery colours. For further details, please contact your Volkswagen retailer.

Combinations.

	Seat upholstery	Carpet	Dashboard	Salsa Red 4Y	Black A1	Platinum Grey Metallic 2R*	Reflex Silver Metallic 8E*	Red Spice Metallic K7*	Mineral Grey Metallic Z8*	Deep Black Pearl Effect 2T*	Blue Graphite Pearl Effect W9*
'Glow' cloth upholstery Standard on S, BlueMotion	Anthracite (HQ)	Anthracite	Black/Anthracite	●	●	●	●	●	●	●	●
'Maxima' cloth upholstery Standard on SE	Anthracite (KU)	Anthracite	Black/Anthracite	●	●	●	●	●	●	●	●
'Brick' cloth upholstery Standard on Sportline	Anthracite (UL)	Anthracite	Black/Anthracite	●	●	●	●	●	●	●	●
'Vienna' leather* † Optional on SE and Sportline	Anthracite (TG)	Anthracite	Black/Anthracite	○	○	○	○	○	○	○	○

* Metallic and pearl effect paints and leather upholstery are optional at extra cost.
 † Some parts of leather interior will contain artificial leather.

● Standard ○ Optional



Engines and gearboxes.

Petrol.

The petrol engine available for the Golf Estate is the 1.6 litre 102 PS. With its smooth running, it's ideal for relaxed cruising, but is still capable of accelerating from 0-62 mph in 12.3 seconds on its way to a top speed of 114 mph where the law permits.

Diesel.

All TDI engines have one thing in common: high levels of performance alongside exceptional economy. Two diesel engines are available for the Golf Estate: the 1.9 litre, developing 105 PS, an engine capable of achieving 54.3 mpg on the Combined fuel cycle* and the sporty 2.0 litre, generating 140 PS which also boasts an impressive economy with 51.4 mpg on the Combined fuel cycle*. Both are available with an optional DPF (Diesel Particulate Filter).

As part of Volkswagen's continued desire to satisfy European emissions legislation, certain diesel engines are now fitted with a Diesel Particulate Filter (DPF). This is part of the exhaust system responsible for cleaning the exhaust gases before they enter the atmosphere. In addition to converting the harmful exhaust gases in the same way as a conventional catalytic converter, the DPF uses advanced technology to reduce the emission of black smoke and soot. It filters the exhaust gases and particles before they leave the vehicle exhaust system, resulting in a cleaner environment and less pollution entering the atmosphere.

Please note, driving conditions within inner-cities and the Channel Islands may not provide optimum conditions for the use of DPF technology. Therefore, it is advised that you consider this before ordering your vehicle with DPF.

Gearboxes.

Depending on the engine you select, you can choose between a five or six speed manual gearbox. You could also opt for the innovative twin-clutch DSG gearbox available with DPF as standard. This fully automatic six speed gearbox, or new seven speed on the SE 1.9 litre TDI DPF 105 PS, combines the sportiness of a manual with the comfort of an automatic, characterised by its smooth gearshifts with no traction interruption.

* Please see the individual specifications in this section for fuel consumption figures.

Model shown is Golf Estate Sportline with optional Winter pack and pearl effect paint.

S, SE, Sportline – 1.6 litre 102 PS. Technical specification.

		Manual	
Engine	Engine type	Four cylinder petrol	
	Cubic capacity, ltrs/cc	1.6/1595	
	Max. output, PS ⁽⁰¹⁾ /kW at rpm	102/75 5600	
	Max. torque, lbs.ft/Nm at rpm	109/148 3800	
	Gearbox	Five speed manual	
Weights, kgs	Unladen weight ⁽⁰²⁾	1278	
	Gross vehicle weight	1900	
	Payload ⁽⁰²⁾	622	
	Axle load limit: Front Rear	960 990	
Trailer load limits, kgs ⁽⁰³⁾	Braked 12% incline	1200	
	Unbraked	670	
	Towbar load limit	75	
	Max. roof load	75	
Performance	Top speed (where law permits), mph (km/h)	114 (184)	
	Acceleration, secs 0 - 62 mph	12.3	
	ABI insurance group	6	
Environmental information	Fuel grade, minimum	Unleaded, 95 RON ⁽⁰⁴⁾	
	Fuel tank capacity, galls/ltrs	12.1/55	
	Official fuel consumption, mpg/ltr per 100 km ⁽⁰⁶⁾		
	Urban	28.5/9.9	
	Extra-urban	47.1/6.0	
	Combined	38.2/7.4	
	Official CO ₂ emission, g/km ⁽⁰⁷⁾	176	
Emission class	EURO 4		
Noise, dB	72.0		

Notes.

- 01 The maximum power output figures are quoted in PS (or Pferdestärke, which is the metric equivalent of horsepower). To convert from metric to imperial horsepower, divide the PS figure by 1.0139.
- 02 Figures are calculated in accordance with manufacturer's criteria. Vehicle unladen weight ranges with 90% tank capacity without driver. The individual unladen weight depends on the specification of the vehicle, this then reduces the possible payload accordingly.
- 03 With increasing altitude the engine performance diminishes. From 1,000 m above sea level and for every 1,000 m thereafter 10% of the vehicle/trailer weight (trailer weight + gross vehicle weight) must be deducted.
- 04 Thanks to the knock control, unleaded four star (at least 95 RON) can be used instead of Super plus unleaded. In order to achieve maximum fuel consumption benefits on the FSI engine, Ultra Low Sulphur Petrol (ULSP) must be used.
- 05 The use of RME and FAME (bio diesel) is not possible.
- 06 Official fuel consumption according to EU Directive 99/94. The consumption calculation according to 1999/100/EC is based on the actual unladen weight of the vehicle. Additional specifications can lead to a higher weight class and hence to consumption figures of this higher weight class. The driving style, road and traffic conditions, environmental influences and vehicle condition can in practice lead to consumption figures, which may differ from those calculated with this standard.
- 07 The weight of a vehicle will influence the level of CO₂ emission it produces; as a result, vehicles with higher levels of specification and factory-fitted options may emit higher levels of CO₂.

S, SE – 1.9 litre TDI 105 PS.

Technical specification.

		Manual – S, SE		Automatic – SE
Engine	Engine type	Four cylinder diesel		Four cylinder diesel
	Cubic capacity, ltrs/cc	1.9/1896		1.9/1896
	Max. output, PS ⁽⁰¹⁾ /kW at rpm	105/77 4000		105/77 4000
	Max. torque, lbs.ft/Nm at rpm	184/250 1900		184/250 1900
	Gearbox	Five speed manual		Seven speed automatic DSG
Weights, kgs	Unladen weight ⁽⁰²⁾	Non DPF 1361	DPF 1361	DPF 1376
	Gross vehicle weight	1990		2010
	Payload ⁽⁰²⁾	629		634
	Axle load limit: Front	1040		1060
	Rear	1000		1000
Trailer load limits, kgs ⁽⁰³⁾	Braked 12% incline	1400		1400
	Unbraked	710		720
	Towbar load limit	75		75
	Max. roof load	75		75
Performance	Top speed (where law permits), mph (km/h)	116 (187)		116 (187)
	Acceleration, secs 0 - 62 mph	11.9		11.9
	ABI insurance group	6		6
Environmental information	Fuel grade, minimum	Diesel Non DPF ⁽⁰⁵⁾		Diesel Non DPF ⁽⁰⁵⁾
	Fuel tank capacity, galls/ltrs	12.1/55		12.1/55
	Official fuel consumption, mpg/ltr per 100 km ⁽⁰⁶⁾			
	Urban	42.8/6.6		–
	Extra-urban	62.8/4.5		–
	Combined	54.3/5.2		–
	Official CO ₂ emission, g/km ⁽⁰⁷⁾	137		–
	Emission class	EURO 4		–
	Noise, dB	73.0		–
	Fuel grade, minimum	Diesel DPF ⁽⁰⁵⁾		Diesel DPF ⁽⁰⁵⁾
	Fuel tank capacity, galls/ltrs	12.1/55		
	Official fuel consumption, mpg/ltr per 100 km ⁽⁰⁶⁾			
	Urban	42.2/6.7		36.2/7.8
	Extra-urban	64.2/4.4		55.4/5.1
	Combined	54.3/5.2		47.1/6.0
	Official CO ₂ emission, g/km ⁽⁰⁷⁾	137		159
	Emission class	EURO 4		EURO 4
Noise, dB	72.0		72.0	

Notes.

- 01 The maximum power output figures are quoted in PS (or Pferdestärke, which is the metric equivalent of horsepower). To convert from metric to imperial horsepower, divide the PS figure by 1.0139.
- 02 Figures are calculated in accordance with manufacturer's criteria. Vehicle unladen weight ranges with 90% tank capacity without driver. The individual unladen weight depends on the specification of the vehicle, this then reduces the possible payload accordingly.
- 03 With increasing altitude the engine performance diminishes. From 1,000 m above sea level and for every 1,000 m thereafter 10% of the vehicle/trailer weight (trailer weight + gross vehicle weight) must be deducted.
- 04 Thanks to the knock control, unleaded four star (at least 95 RON) can be used instead of Super plus unleaded. In order to achieve maximum fuel consumption benefits on the FSI engine, Ultra Low Sulphur Petrol (ULSP) must be used.
- 05 The use of RME and FAME (bio diesel) is not possible.
- 06 Official fuel consumption according to EU Directive 99/94. The consumption calculation according to 1999/100/EC is based on the actual unladen weight of the vehicle. Additional specifications can lead to a higher weight class and hence to consumption figures of this higher weight class. The driving style, road and traffic conditions, environmental influences and vehicle condition can in practice lead to consumption figures, which may differ from those calculated with this standard.
- 07 The weight of a vehicle will influence the level of CO₂ emission it produces; as a result, vehicles with higher levels of specification and factory-fitted options may emit higher levels of CO₂.

BlueMotion – 1.9 litre TDI DPF 105 PS.

Technical specification.

		Manual	
Engine	Engine type	Four cylinder diesel	
	Cubic capacity, ltrs/cc	1.9/1896	
	Max. output, PS ⁽⁰¹⁾ /kW at rpm	105/77 4000	
	Max. torque, lbs.ft/Nm at rpm	184/250 1900	
	Gearbox	Five speed manual	
Weights, kgs	Unladen weight ⁽⁰²⁾	1357	
	Gross vehicle weight	1970	
	Payload ⁽⁰²⁾	613	
	Axle load limit: Front	1020	
	Rear	1000	
Trailer load limits, kgs ⁽⁰³⁾	Braked 12% incline	1400	
	Unbraked	710	
	Towbar load limit	75	
	Max. roof load	75	
Performance	Top speed (where law permits), mph (km/h)	117 (189)	
	Acceleration, secs 0 - 62 mph	11.9	
	ABI insurance group	TBA	
Environmental information	Fuel grade, minimum	Diesel DPF ⁽⁰⁵⁾	
	Fuel tank capacity, galls/ltrs	12.1/55	
	Official fuel consumption, mpg/ltr per 100 km ⁽⁰⁶⁾		
	Urban	47.9/5.9	
	Extra-urban	72.4/3.9	
	Combined	61.4/4.6	
	Official CO ₂ emission, g/km ⁽⁰⁷⁾	122	
	Emission class	EURO 4	
Noise, dB	72.0		

Notes.

- 01 The maximum power output figures are quoted in PS (or Pferdestärke, which is the metric equivalent of horsepower). To convert from metric to imperial horsepower, divide the PS figure by 1.0139.
- 02 Figures are calculated in accordance with manufacturer's criteria. Vehicle unladen weight ranges with 90% tank capacity without driver. The individual unladen weight depends on the specification of the vehicle, this then reduces the possible payload accordingly.
- 03 With increasing altitude the engine performance diminishes. From 1,000 m above sea level and for every 1,000 m thereafter 10% of the vehicle/trailer weight (trailer weight + gross vehicle weight) must be deducted.
- 04 Thanks to the knock control, unleaded four star (at least 95 RON) can be used instead of Super plus unleaded. In order to achieve maximum fuel consumption benefits on the FSI engine, Ultra Low Sulphur Petrol (ULSP) must be used.
- 05 The use of RME and FAME (bio diesel) is not possible.
- 06 Official fuel consumption according to EU Directive 99/94. The consumption calculation according to 1999/100/EC is based on the actual unladen weight of the vehicle. Additional specifications can lead to a higher weight class and hence to consumption figures of this higher weight class. The driving style, road and traffic conditions, environmental influences and vehicle condition can in practice lead to consumption figures, which may differ from those calculated with this standard.
- 07 The weight of a vehicle will influence the level of CO₂ emission it produces; as a result, vehicles with higher levels of specification and factory-fitted options may emit higher levels of CO₂.

SE, Sportline – 2.0 litre TDI 140 PS.

Technical specification.

		Manual	Automatic
Engine	Engine type	Four cylinder diesel	Four cylinder diesel
	Cubic capacity, ltrs/cc	2.0/1968	2.0/1968
	Max. output, PS ⁽⁰¹⁾ /kW at rpm	140/103 4000	140/103 4000
	Max. torque, lbs.ft/Nm at rpm	236/320 1750	236/320 1750
	Gearbox	Six speed manual	Six speed automatic DSG
Weights, kgs	Unladen weight ⁽⁰²⁾	Non DPF 1402	DPF 1390
	Gross vehicle weight	2030	2010
	Payload ⁽⁰²⁾	628	620
	Axle load limit: Front	1080	1060
	Rear	1000	1000
Trailer load limits, kgs ⁽⁰³⁾	Braked 12% incline	1500	1500
	Unbraked	730	740
	Towbar load limit	75	75
	Max. roof load	75	75
Performance	Top speed (where law permits), mph (km/h)	127 (205)	126 (203)
	Acceleration, secs 0 - 62 mph	9.8	9.7
	ABI insurance group	12	12
Environmental information	Fuel grade, minimum	Diesel Non DPF ⁽⁰⁵⁾	Diesel Non DPF ⁽⁰⁵⁾
	Fuel tank capacity, galls/ltrs	12.1/55	12.1/55
	Official fuel consumption, mpg/ltr per 100 km ⁽⁰⁶⁾		
	Urban	40.9/6.9	–
	Extra-urban	60.1/4.7	–
	Combined	51.4/5.5	–
	Official CO ₂ emission, g/km ⁽⁰⁷⁾	145	–
	Emission class	EURO 4	–
	Noise, dB	72.0	–
	Fuel grade, minimum	Diesel DPF ⁽⁰⁵⁾	Diesel DPF ⁽⁰⁵⁾
	Fuel tank capacity, galls/ltrs	12.1/55	
	Official fuel consumption, mpg/ltr per 100 km ⁽⁰⁶⁾		
	Urban	40.4/7.0	35.3/8.0
	Extra-urban	58.9/4.8	56.5/5.0
	Combined	50.4/5.6	46.3/6.1
	Official CO ₂ emission, g/km ⁽⁰⁷⁾	148	160
	Emission class	EURO 4	EURO 4
Noise, dB	72.0	72.0	

Notes.

- 01 The maximum power output figures are quoted in PS (or Pferdestärke, which is the metric equivalent of horsepower). To convert from metric to imperial horsepower, divide the PS figure by 1.0139.
- 02 Figures are calculated in accordance with manufacturer's criteria. Vehicle unladen weight ranges with 90% tank capacity without driver. The individual unladen weight depends on the specification of the vehicle, this then reduces the possible payload accordingly.
- 03 With increasing altitude the engine performance diminishes. From 1,000 m above sea level and for every 1,000 m thereafter 10% of the vehicle/trailer weight (trailer weight + gross vehicle weight) must be deducted.
- 04 Thanks to the knock control, unleaded four star (at least 95 RON) can be used instead of Super plus unleaded. In order to achieve maximum fuel consumption benefits on the FSI engine, Ultra Low Sulphur Petrol (ULSP) must be used.
- 05 The use of RME and FAME (bio diesel) is not possible.
- 06 Official fuel consumption according to EU Directive 99/94. The consumption calculation according to 1999/100/EC is based on the actual unladen weight of the vehicle. Additional specifications can lead to a higher weight class and hence to consumption figures of this higher weight class. The driving style, road and traffic conditions, environmental influences and vehicle condition can in practice lead to consumption figures, which may differ from those calculated with this standard.
- 07 The weight of a vehicle will influence the level of CO₂ emission it produces; as a result, vehicles with higher levels of specification and factory-fitted options may emit higher levels of CO₂.

The technology.

Transmission

- Front-wheel drive
- Five speed manual gearbox: 1.6 litre 102 PS, 1.9 litre TDI 105 PS
- Six speed manual gearbox: 2.0 litre TDI 140 PS
- Six speed automatic DSG gearbox: 2.0 litre TDI DPF 140 PS
- Seven speed automatic DSG gearbox: 1.9 litre TDI DPF 105 PS

Steering

- Maintenance-free rack and pinion steering rack with speed related, electronically controlled servo assistance
- Height and reach adjustable and collapsible safety steering column

Running gear

- Front suspension uses coil springs with telescopic shock absorbers; all elements integrated in chassis legs
- Rear suspension with oil pressure shock absorbers and separate springs
- Wheel control: front through chassis legs and (lower) triangular wishbones (directionally stabilising steering roll radius), at rear through four link suspension with integrated anti-roll bar
- Front anti-roll bar
- Electronic Stabilisation Programme (ESP) including Hydraulic Brake Assist (HBA), Electronic Differential Lock (EDL) and Traction Control (ASR)

Dimensions.

Exterior dimensions		
Length, mm		4566
Width – excluding door mirrors, mm		1781
Width – opened front/rear doors, mm		3640/3409
Height, mm		1504
Height – opened bonnet/floor, mm		1764
Height – opened tailgate/floor, mm		2061
Wheelbase, mm		2578

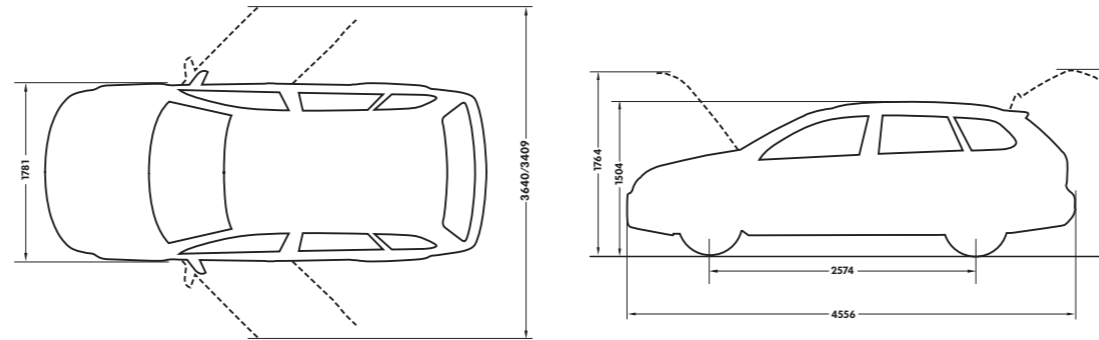

Engines

- Front transversely-mounted engine
- 1.6 litre/102 PS⁽⁰¹⁾ (75 kW) petrol engine.
Four cylinder in-line engine, aluminium cylinder head, two valves per cylinder with roller rocker valves, programmed ignition with cylinder-selective anti-knock control, four single spark ignition coils, Longlife spark plugs, exhaust gas recirculation, three-way front catalyst, lambda control
- 1.9 litre/105 PS⁽⁰¹⁾ (77 kW) diesel engine.
Four cylinder in-line engine, cast iron cylinder block, two valves per cylinder, electronically controlled direct injection with pump injector unit ('Pumpe Düse'), oil cooler, intercooler, exhaust gas recirculation, turbocharger with variable turbine geometry, catalytic converter or catalytic coated diesel particulate filter (DPF)
- 2.0 litre/140 PS⁽⁰¹⁾ (103 kW) diesel engine.
Four cylinder in-line engine, cast iron cylinder block, four valves per cylinder (two valves per cylinder with DPF), electronically controlled direct injection with pump injector unit ('Pumpe Düse'), oil cooler, intercooler, exhaust gas recirculation, turbocharger with variable turbine geometry, catalytic converter or catalytic coated diesel particulate filter (DPF)

¹ The maximum power output figures are quoted in PS (or Pferdestärke, which is the metric equivalent of horsepower). To convert from metric to imperial horsepower, divide the PS figure by 1.0139.

Volkswagen service for your peace of mind.

The Volkswagen Warranty.

Three-year Warranty.

All Volkswagen Golf Estates come with a three-year/60,000 miles warranty, which protects your car against the failure of most mechanical and electrical components due to manufacturing defects. This comprises a two-year manufacturer's warranty with unlimited mileage plus a further one-year/60,000 miles (whichever is soonest) Retailer Warranty. Should the mileage exceed 60,000 miles within the first two years, the manufacturer's two-year warranty will still be valid. If an additional warranty for subsequent years or higher mileage is desired, it may be purchased from an authorised Volkswagen retailer or repairer; however, this additional warranty must be purchased before the mileage reaches 60,000*. Full details of the three-year warranty are available from your authorised Volkswagen retailer or repairer.

* All warranty work must be completed by an authorised Volkswagen retailer or repairer.

Three-year Paint Warranty.

The paintwork of the Golf Estate is covered against manufacturing defects for a period of three years. Naturally, the Golf Estate must be cared for in compliance with the operating instructions which will be found in your vehicle handbook. Please consult your authorised Volkswagen retailer or repairer for full warranty details.

12-year Body Protection Warranty.

The internal body sections and panels of the Golf Estates are covered against rusting through from the inside for 12 years. Naturally, the Golf Estate must be cared for in compliance with the operating instructions. Please consult your authorised Volkswagen retailer or repairer for full warranty details.

Approved Accessories.

A comprehensive range of accessories from alloy wheels to carpet mats is available to complement the factory-fitted option list. Volkswagen Approved accessories purchased from and fitted by your authorised Volkswagen retailer at the point of vehicle sale will also benefit from the three-year vehicle warranty.

Service Intervals.

Volkswagen are pleased to offer you a choice on how your Golf Estate is serviced. The appropriate selection is entirely dependent on how the car is likely to be driven and its general use. To help you identify which type of service would be most suitable, please refer to the following guide.

The Time and Distance Service is recommended for vehicles that will cover less than 10,000 miles in 12 months and if the vehicle is likely to be used in the following way:

- Predominantly urban driving, short journeys with frequent cold starts.
- Activities regularly producing high engine loading, e.g. frequent hill climbs, driving with vehicle fully loaded and towing.
- Uneconomical driving style using high rpms with heavy acceleration and heavy braking.

The service intervals for the Time and Distance Service are as follows:

- Oil change service
Every 10,000 miles/1 year (whichever is soonest).
- Interval service
Every 20,000 miles/2 years (whichever is soonest).
- Inspection service
Every 40,000 miles/3 years (whichever is soonest).

The LongLife Service is recommended for vehicles with a daily mileage of more than 25 miles where the vehicle is driven regularly mainly on longer distance journeys. The vehicle is driven mainly at a constant speed with minimum vehicle and engine loading, minimal towing and driven in an economical manner.

With the LongLife Service the vehicle can cover anywhere between 10,000[†] and a maximum of 18,000[†] miles or 24 months (whichever is soonest) between oil changes. Inspection service is typically in the third year of ownership and thereafter every second year, for vehicles with an approximate annual mileage of 10,000 miles.

[†] Please note that mileages are approximate as the service indicator system uses kilometres as the distance measurement. Please consult your authorised Volkswagen retailer or repairer for advice and full details.

Extended Warranty.

You may purchase additional protection from your authorised Volkswagen retailer or repairer, or contact 0870 9000 115.

Volkswagen Finance[‡].

Volkswagen Finance specialises in providing funding solutions for Volkswagen drivers. Whether your Volkswagen is for private or business use, you can choose from a range of funding options.

- Solutions – a personal contract plan
- Hire purchase
- Lease purchase
- Finance lease
- Contract hire

With all Volkswagen Finance products you can choose a fixed-cost maintenance plan to help you budget for your servicing and maintenance costs.

No matter what finance product you choose, your local Volkswagen retailer will be able to provide you with a personalised quote that could meet your budget and vehicle needs.

[‡] Volkswagen Finance is a trading name of Volkswagen Financial Services (UK) Limited. An offer of finance depends on certain conditions. Available to people over 18 in the UK only.

Volkswagen Insurance[±].

Competitive and comprehensive motor insurance designed especially for Volkswagen drivers. All new and Approved Used Volkswagens come with complimentary seven-day cover upon request – we'll e-mail a cover note straight to your retailer, enabling them to tax your car easily. This way, you can drive straight out of the showroom. Taking out annual cover is easy and it can start when the seven-day cover expires. For more information contact your local Volkswagen retailer or call 0800 051 3136.

[±] Volkswagen Insurance is underwritten and administered by Zurich Insurance Company. Volkswagen Insurance is a trading name of Volkswagen Insurance Service (Great Britain) Limited which is an appointed representative of Volkswagen Financial Services (UK) Limited. Zurich Insurance Company and Volkswagen Financial Services (UK) Limited are both authorised and regulated by the Financial Services Authority.

Volkswagen Roadside Assistance.

Every new car is registered for Volkswagen Roadside Assistance for one year. This provides vehicle home and roadside recovery in the unlikely event of a breakdown in the UK and Europe (subject to conditions). Volkswagen Roadside Assistance can also be purchased for subsequent years. For full details, please contact your authorised Volkswagen retailer.

Tax Free Sales.

For full details, please contact your authorised Volkswagen retailer.

CO₂ Emission.

Increased weight of a vehicle, including higher trim levels and the addition of options will have a detrimental influence on the level of fuel consumption and CO₂ emissions produced.

The CO₂ and fuel consumption figures are obtained from tests on a representative vehicle of the type, conducted and approved in accordance with Council Directive 80/1268/EEC as amended by Directive 1999/100/EC (or later) on the approximation of the laws of the member states relating to the carbon dioxide emissions and the fuel consumption of motor vehicles.

Please Note:

Some illustrations in this brochure do not necessarily reflect UK specifications and may not be available. In particular, controls and some items of equipment are positioned differently for the UK.

The specifications contained in this brochure are for information purposes only and are subject to change. If you require any specific feature, you must consult your authorised Volkswagen retailer who is regularly updated with any change in specification. Please check model availability and full specification details with your authorised Volkswagen retailer prior to ordering.

Note: We would like to advise you that telephone calls to Volkswagen Customer Care may be monitored and recorded as part of our training and quality assurance processes. All our monitoring and recording processes meet Ofcom regulations.